

Network Camera

Installation Manual

Before operating the unit please read this manual thoroughly and retain it for future reference.

Bullet Series

1080 HD 5MP 8 Version 1.1.0

www.RedLeafSecurity.net
© 2012 Redleaf Corporation

Welcome

Thank you for purchasing our IP camera. This Quick Reference guide describes how to install and configure your RedLeaf IP camera. Before you start to install and use your new camera, please read these instructions carefully. Please keep this start guide well for future reference. Please open the accessory bag to check the items one by one in accordance with the list below. Contact your local retailer ASAP if something is missing or damaged in the bag. For the most up-to-date information about this product, visit the official RedLeaf website at www.redleafsecurity.net

⚠ Please read these precaution notes before the operation:

● 1 . Electrical safety

All installation and operation here should conform to your local electrical safety codes. The power shall conform to the requirement in the SELV (Safety Extra Low Voltage) and the Limited power source is rated 12V DC in the IEC60950-1.

⚠ Please note: Do not connect these two power supplying sources to the device at the same time; it may result in device damage!

We assume no liability or responsibility for all the fires or electrical shock caused by improper handling or installation.

We are not liable for any problems caused by unauthorized modification or attempted repair.

● 2 . Transportation security

Heavy stress, violent vibration or water splash are not allowed during transportation, storage and installation.

● 3 . Installation

Do not apply power to the camera before completing installation. Please install the proper power cut-off device during the installation connection. Always follow the instruction guide the manufacturer recommended.

● 4 . Qualified engineers needed

All the examination and repair work should be done by the qualified service engineers. We are not liable for any problems caused by unauthorized modifications or attempted repair.

● 5 . Environment

This series IP camera should be installed in a cool, dry place away from direct sunlight, inflammable, explosive substances and etc. Please keep it away from the electromagnetic radiation object and environment. Please make sure the CCD (CMOS) component is out of the radiation of the laser beam device. Otherwise it may result in CCD (CMOS) optical component damage.

Welcome

Please keep the sound ventilation. Do not allow the water and other liquid falling into the camera. Thunder-proof device is recommended to be adopted to better prevent thunder. The grounding studs of the product are recommended to be grounded to further enhance the reliability of the camera.

6. Daily Maintenance

Please shut down the device and then unplug the power cable before you begin daily maintenance work. Do not touch the CCD (CMOS) optic component. You can use the blower to clean the dust on the lens surface. Always use the dry soft cloth to clean the device. If there is too much dust, please use the water to dilute the mild detergent first and then use it to clean the device. Finally use the dry cloth to clean the device. Please put the dust proof cap to protect the CCD (CMOS) component when you do not use the camera.

7. Accessories

Be sure to use all the accessories recommended by manufacturer. Before installation, please open the package and check all the components are included. Contact your local retailer ASAP if something is broken in your package.

Accessory Name	Amount
RLC Unit	1
Quick Start Guide	1
12V to 24V Conversion Cable (For AC 24V series product only)	1
Installation Location Map	1
Resource CD	1

Framework

1.1 Multiple-function Combination Cable

You can refer to the following figure for multiple-function combination cable information. See -Figure 1-1.

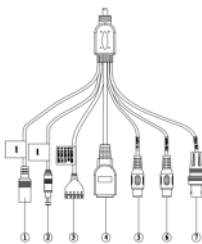

Figure 1-1

Please refer to the following sheet for detailed information.

SN	port Name	Function	Connection	Note
1	DC 12V/AC 24V	Power input port	-	Power port, input DC 12V/AC 24V (Please use the provided conversion cable)
2	Reset	Reset port	-	Hardware reset function. Press it for 3 to 5 seconds; system hardware can restore default setup.
3	I/O	I/O port	-	Connect to I/O port.
4	LAN	Network port	Ethernet port	Connect to standard Ethernet cable.
5	AUDIO IN	Audio input port	RCA	Input audio signal. It can receive the analog audio signal from the pickup.
6	AUDIO OUT	Audio output port	RCA	Output audio signal to the devices such as the sound box.
7	VIDEO OUT	Video output port	BNC	Output analog video signal. It can connect to the TV monitor to view the video.

Please refer to the following sheet for detailed I/O port information.

Port Name	Name	Note
I/O Port	ALARM_COM	Alarm output public port.
	ALARM_NO	Alarm output port. It is to output the alarm signal to the alarm device. NO: normal open alarm output port. It works with the ALARM_COM port.
	ALARM_IN1	Alarm input port 1. It is to receive the on-off signal from the external alarm source.
	ALARM_IN2	Alarm input port 2. It is to receive the on-off signal from the external alarm source.
	GND	Ground port

Framework

1.2 Framework and Dimension

Please refer to the following figure for dimension information. The unit is mm. See -Figure 1-2 and -Figure 1-3.

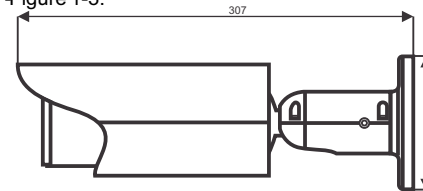

Figure 1-2

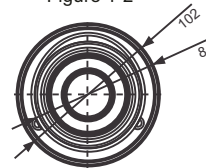

Figure 1-3

1.3 Bidirectional Talk

1.3.1 Device- end to PC-end Device Connection

Please connect the speaker or the MIC to the audio input port of the device. Then connect the earphone to the audio output port of the PC. Login the Web and then click the Audio button to enable the bidirectional talk function. You can see the button becomes orange after you enabled the audio talk function. Click Audio button again to stop the bidirectional talk function. Listening Operation At the device end, speak via the speaker or the pickup, and then you can get the audio from the earphone or sound box at the pc-end.

1.3.2 PC-end to the Device- end Device Connection

Connect the speaker or the MIC to the audio input port of the PC and then connect the earphone to the audio output port of the device. Login the Web and then click the Audio button to enable the bidirectional talk function. You can see the button becomes orange after you enabled the audio talk function. Click Audio button again to stop the bidirectional talk function.

Please note the listening operation is null during the bidirectional talk process.

Listening Operation

At the PC-end, speak via the speaker or the pickup, and then you can get the audio from the earphone or sound box at the device-end

1.3.3 Alarm Setup

Please follow the steps listed below for local alarm input and output connection.

- 1) Connect the alarm input device to the alarm input port (No.3 pin or No.4 pin) of the I/O cable.
- 2) Connect the alarm output device to the alarm output port (No.2 pin) and alarm output public port (No.1 pin). The alarm output port supports NO (normal open) alarm device only.
- 3) Open the Web, go to the Figure. Please set the alarm input 01 port for the first channel of the I/O cable (No.3 pin). The alarm input 02 is for the 2nd channel of I/O cable (No.4 pin). Then you can select the corresponding type (NO/NC.)
- 4) Set the WEB alarm output. The alarm output 01 is for the alarm output port of the device. It is the No.2 pin of the I/O cable.

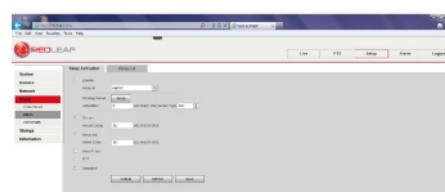

Figure 1-4

Please refer to figure 1-5 for alarm input information. Alarm input: When the input signal is idle or

Framework

grounded, the device can collect the different statuses of the alarm input port. When the input signal is connected to the 5V or is idle, the device collects the logic "1". When the input signal is grounded, the device collects the logic "0".

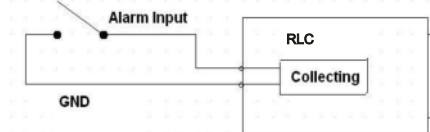

Figure 1-5

Please refer to figure 1-6 for alarm output information. Port ALARM_COM and Port ALARM_NO composes an on-off button to provide the alarm output. If the type is NO, this button is normal open. The button becomes on when there is an alarm output. If the type is NC, this button is normal off. The button becomes off when there is an alarm output.

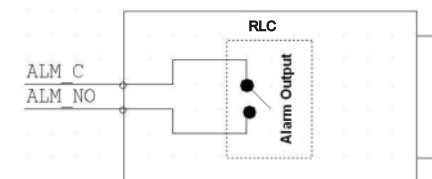

Figure 1-6

Installation

2 Installation

2.1 Device Installation

Please follow the steps listed below to install the device. Please refer to -Figure 2-1 for reference.

- Please draw the installation holes in the installation surface and then mark three expansion bolts holes in the surface. Insert three bolts in the hole and secure firmly.
- Please line up the installation holes of the bottom of the pendant mount bracket to the installation holes in the surface. Then insert the three bolts to the holes of the bottom of the bracket. Finally fasten the device on the installation surface.

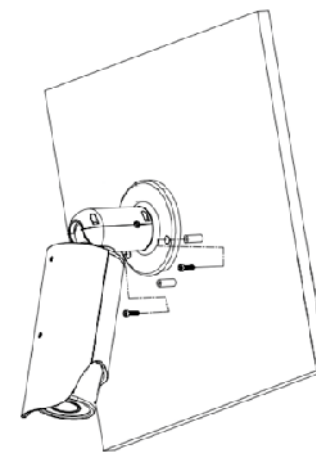

Figure 2-1

2-2 SD Card Installation

Use the inner hex wrench from the installation accessories bag to remove the four inner hex screws from the rear cover. Please refer to -Figure 2-2 to find the SD card slot position. Insert the SD card and the fix the four screws of the rear cover.

Important

- Please make sure the cable connection between the power board and the main board is firm. Otherwise, it may result in device malfunction.
- The rear cover of the device adopts the waterproof design. Please secure four screws firmly after you complete the SD card installation.

Installation

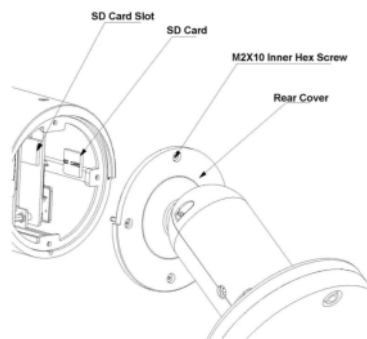

Figure 2-2

2-3 Lens Adjustment

Turn counter clockwise to remove the lens cover, now you can see the iris front and rear control rod. The front control rod is to focus and the rear control rod is to zoom. See - Figure 2-3. Please turn clockwise to fix the lens cover back firmly. Important

- Please remove the sunshield first and remove the lens cover if you can not unfasten the lens cover.
- The lens cover has the waterproof function. Please make sure it is secure after you complete the lens adjustment.
- HFW3202C series product has the default motorized zoom lens. You do not need to adjust manually.

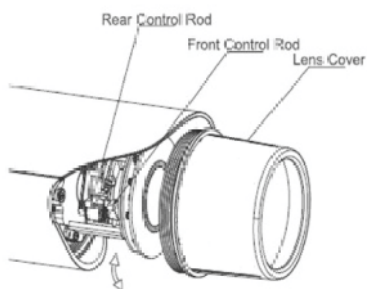

Figure 2-3

2-4 Bracket Adjustment

You can use a M4 inner hex screw to control the bracket. Please use the inner hex wrench from the installation accessories bag to unfasten the screw. See -Figure 24. The horizontal angle of the rear cover can rotate 360°, the tilt angle can rotate 90° and the chassis can rotate 360°. Please use the inner hex wrench to secure the screw firmly after you complete the setup. Important

- Please make sure the M4 inner hex screw is firm, otherwise it may result in chassis vibration and the camera can not fix to a specified angle.

Quick Configuration Tool

3 Quick Configuration

3.1 Overview

Quick configuration tool can search current IP address, modify IP address. At the same time, you can use it to upgrade the device. Please note the tool only applies to the IP addresses in the same segment.

3.2 Operation

Double click the "ConfigTools.exe" icon, you can see an interface is shown as in -Figure 3-1. In the device list interface, you can view device IP address, port number, subnet mask, default gateway, MAC address and etc.



Figure 3-1

Quick Configuration Tool

Select one IP address and then right click mouse and change the IP address.

▲ Note:

You can set the IP address, subnet mask and gateway for the IPC and PC. Please note IPC IP address and PC IP address shall be in the same network segment if there is no router. IPC default IP address is 192.168.1.108. If there is a router, please set the corresponding gateway and subnet mask.

The factory default user name is admin and password is admin.

For security reasons, please modify your password after you first login.

For detailed WEB operation, please refer to the IPC Web Operation Manual in the resource CD.

Select the "Open Device Web" item; you can go to the corresponding web login interface. See -Figure 3-2.



Figure 3-2

If you want to modify the device IP address without logging in the device web interface, you can go to the configuration tool main interface to set. In the configuration tool search interface, please select a device IP address and then double click it to open the login interface. Or you can select an IP address and then click the Login button to go to the login interface. See -Figure 3-3.

In -Figure 3-4, you can view device IP address, user name, password and port. Please modify the corresponding information to login.

Please note the port information here shall be identical with the port value you set in TCP port in Web Network interface. Otherwise, you can not login the device.

If you are using device background upgrade port 3800 to login, other setups are all invalid.

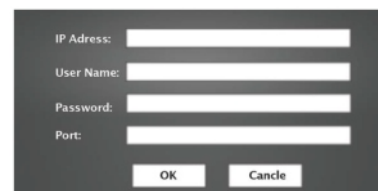

Figure 3-3

After you logged in, the configuration tool main interface is shown as below. See - figure 3-4

▲ For detailed information and operation instruction of the quick configuration tool, please refer to the Quick Configuration Tool User's Manual included in the resources CD.

Web Operation

4 Web Operation

This series RLC product support the Web access and management via PC.

Web includes several modules: monitor channel preview, system configuration, alarm and etc.

4.1 Network Connection

Please follow the steps listed below for network connection.

- Make sure the RLC has connected to the network properly.
- RLC IP address and PC IP address shall be in the same network segment. IPC default IP address is 192.168.1.108. If there is router, please set the corresponding gateway and subnet mask.
- Use order ping ***.***.***.***/* (IP camera address) to check connection is OK or not.

4.2 Login and Logout

Open IE and input IP camera address in the address bar.

For example, if your camera IP is 192.168.1.108, then please input http:// 192.168.1.108 in IE address bar. See -Figure 4-1.

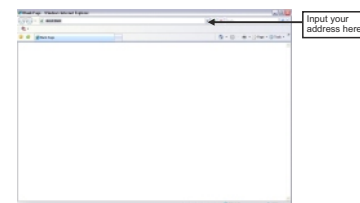

Figure 4-1

The login interface is shown as below. See -Figure 4-2

Please input your user name and password. Default factory name is admin and password is admin.

▲ Note:

For security reasons, please modify your password after you first login.



Figure 4-2

If it is your first time to login in, system pops up warning information to ask you whether install control web rec. cab or not after you logged in for one minute. Please click OK button, system can automatically install the control. When system is upgrading, it can overwrite the previous Web too. If you can't download the ActiveX file, please check whether you have installed the plug-in to disable the control download. Or you can lower the IE security level. See -Figure 4-3 and 4-4.

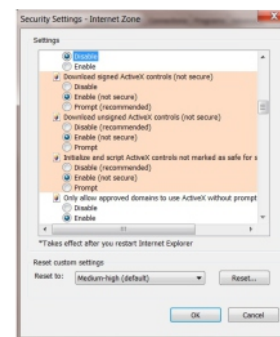

Figure 4-3

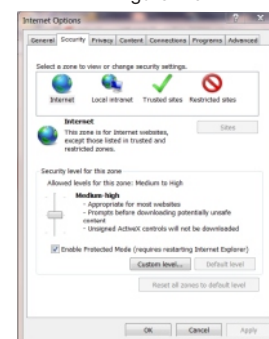

Figure 4-4

Web Operation

After you logged in, you can see the main window. See -figure 4-5.

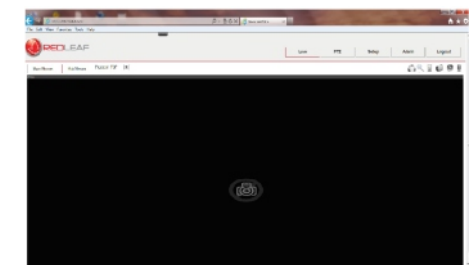

Figure 4-5

Please refer to the Web Operation Manual included in the resource CD for detailed operation instruction.

Appendix: Toxic or Hazardous Materials or Elements

Component Name	Toxic or Hazardous Materials or Elements					
	Pb	Hg	Cd	CrVI	PBB	PBDE
Circuit Board Component	○	○	○	○	○	○
Case	○	○	○	○	○	○
Wire and Cable	○	○	○	○	○	○
Packing Components	○	○	○	○	○	○
Accessories	○	○	○	○	○	○

○: Indicates that the concentration of the hazardous substance in all homogeneous materials in the parts is below the relevant threshold of the SJ/T11363-2006 standard.

X: Indicates that the concentration of the hazardous substance of at least one of all homogeneous materials in the parts is above the relevant threshold of the SJ/T11363-2006 standard. During the environmental-friendly use period (EFUP) period, the toxic or hazardous substance or elements contained in products will not leak or mutate so that the use of these (substances or elements) will not result in any severe environmental pollution, any bodily injury or damage to any assets. The consumer is not authorized to process such kind of substances or elements, please return to the corresponding local authorities to process according to your local government statutes.

▲ Note:

- This quick start guide is for reference only. Slight difference may be found in user interface.
- All the designs and software here are subject to change without prior written notice.
- All trademarks and registered trademarks are the properties of their respective owners.
- If there is any uncertainty or controversy, please refer to the final explanation of us.
- Please visit our website or contact your local service engineer for more information.